



WTD95- 2 mm

HEMYÜZ KAPI SİSTEMİ  
FLAT DOOR SYSTEM





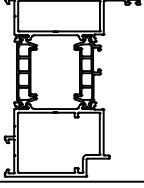
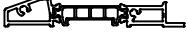
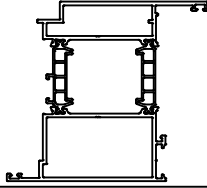
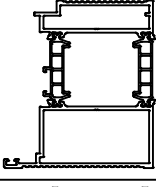
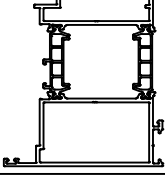

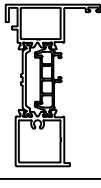
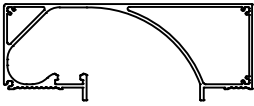



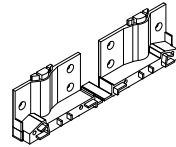

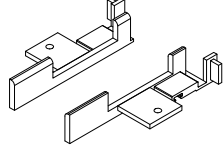

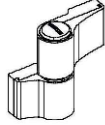

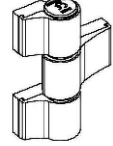
**ASISTAL**

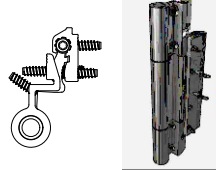
PROFİL VE AKSESUAR LİSTELERİ  
*PROFILE & ACCESSORIES LISTS*

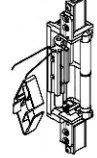
## PROFİL LİSTESİ - PROFILES LIST

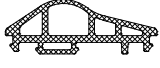
WTD95 01				
KASA PROFİLİ FRAME PROFILE	AĞIRLIK / Weight 2,213 kg/mt			
WTD95 02				
EŞİK PROFİLİ BOTTOM RAIL PROFILE	AĞIRLIK / Weight 0,972 kg/mt			
WTD95 10				
İÇE AÇILIR KAPI KANAT PROFİLİ SASH PROFILE FOR INNER OPENING	AĞIRLIK / Weight 2,614 kg/mt			
WTD95 11 (Siyah Mat Eloksal)				
İÇE AÇILIR KAPI KANAT PROFİLİ SASH PROFILE FOR INNER OPENING	AĞIRLIK / Weight 2,267 kg/mt			
WTD95 12				
İÇE AÇILIR KAPI KANAT PROFİLİ SASH PROFILE FOR INNER OPENING	AĞIRLIK / Weight 2,385 kg/mt			
WTD95 A01				
ADAPTÖR PROFİLİ ADAPTER PROFILE	AĞIRLIK / Weight 0,250 kg/mt			
WTD95 42				
ADAPTÖR PROFİLİ ADAPTER PROFILE	AĞIRLIK / Weight 1,534 kg/mt			
DH-01				
KOL PROFİLİ HANDLE PROFILE	AĞIRLIK / Weight 2,075 kg/mt			

## AKSESUAR LİSTESİ - ACCESSORIES LIST

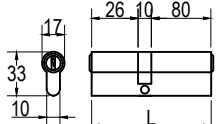
EP1-01			WTD95-PL01		
DIŞ CAM FİTİLİ - 3 mm <i>OUTER GLAZING GASKET</i>	KOLİ MİKTARI/Package 240 mt / 15 kg		PVC KASA KAPAK <i>PVC FRAME COVER</i>	KOLİ MİKTARI/Package Adet / Piece	
KC 02			WTD95-PL02		
CAM FİTİLİ - 2 mm <i>GLAZING GASKET</i>	KOLİ MİKTARI/Package 100 mt / 4,5 kg		PVC KANAT KAPAK <i>PVC SASH COVER</i>	KOLİ MİKTARI/Package Adet / Piece	
EP2-01			EP95-H01		
İÇ CAM FİTİLİ - 3 mm <i>INNER GLAZING GASKET</i>	KOLİ MİKTARI/Package 440 mt / 15 kg		YÜZEYSEL 2'Lİ MENTEŞE <i>SURFACE HINGE</i>	KOLİ MİKTARI/Package Adet / Piece	
EP2-02			EP95-H02		
İÇ CAM FİTİLİ - 4 mm <i>INNER GLAZING GASKET</i>	KOLİ MİKTARI/Package 300 mt / 15 kg		YÜZEYSEL 3'Lİ MENTEŞE <i>SURFACE HINGE</i>	KOLİ MİKTARI/Package Adet / Piece	
EP2-03			EP95-H03		
İÇ CAM FİTİLİ - 5 mm <i>INNER GLAZING GASKET</i>	KOLİ MİKTARI/Package 250 mt / 15 kg		SİSTEM MENTEŞE <i>ROLLER HINGE</i>	KOLİ MİKTARI/Package Adet / Piece	
EPW3-01			EP95-H04		
KANAT BİNİ FİTİLİ <i>SASH GASKET</i>	KOLİ MİKTARI/Package		GİZLİ MENTEŞE <i>CONCEALED HINGE</i>	KOLİ MİKTARI/Package Adet / Piece	
EPW3-02			ASI-LS 04852		
KASA BİNİ FİTİLİ-COEX <i>FRAME GASKET</i>	KOLİ MİKTARI/Package		ÇOK NOKTADAN KİLİTLEME <i>MULTIPOINT LOCK</i>	KOLİ MİKTARI/Package Adet / Piece	
EP95-01			ASI-LS 04862		
ORTA BİNİ FİTİLİ <i>CENTRAL GASKET</i>	KOLİ MİKTARI/Package		GİZLİ MENTEŞE <i>CONCEALED HINGE</i>	KOLİ MİKTARI/Package Adet / Piece	
EP95-02			ASI-DH 002		
EŞİK FİTİLİ <i>GASKET FOR TRHESHOLD</i>	KOLİ MİKTARI/Package		KAPI KOLU <i>DOOR HANDLE</i>	KOLİ MİKTARI/Package Adet / Piece	
			ASI-BRL 116		
			116 LİK BAREL <i>CYLINDER 116</i>	KOLİ MİKTARI/Package Adet / Piece	

**WTD95- 2 mm**

HEMYÜZ KAPI SİSTEMİ  
FLAT DOOR SYSTEM

**ASISTAL**

**PROFİL DETAYLARI**  
*PROFILE DETAILS*

# WTD95 - 2 mm

HEMYÜZ KAPI SİSTEMİ  
FLAT DOOR SYSTEM

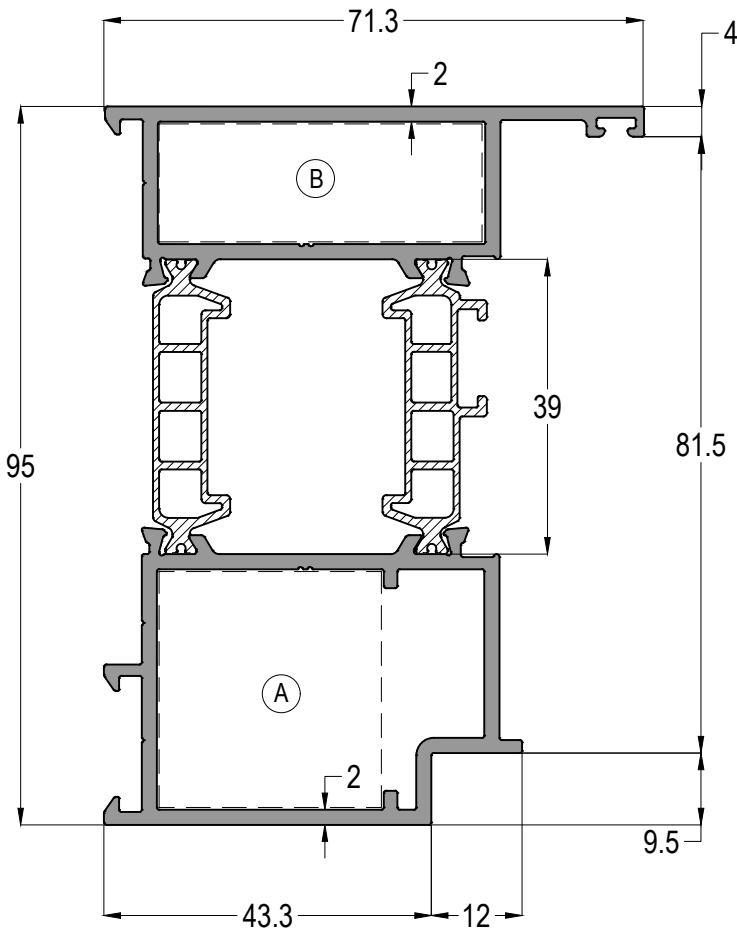

## WTD95 01



AĞIRLIK / Weight

2,213 kg/mt

# WTD95 - 2 mm

HEMYÜZ KAPI SİSTEMİ  
FLAT DOOR SYSTEM

**ASISTAL**

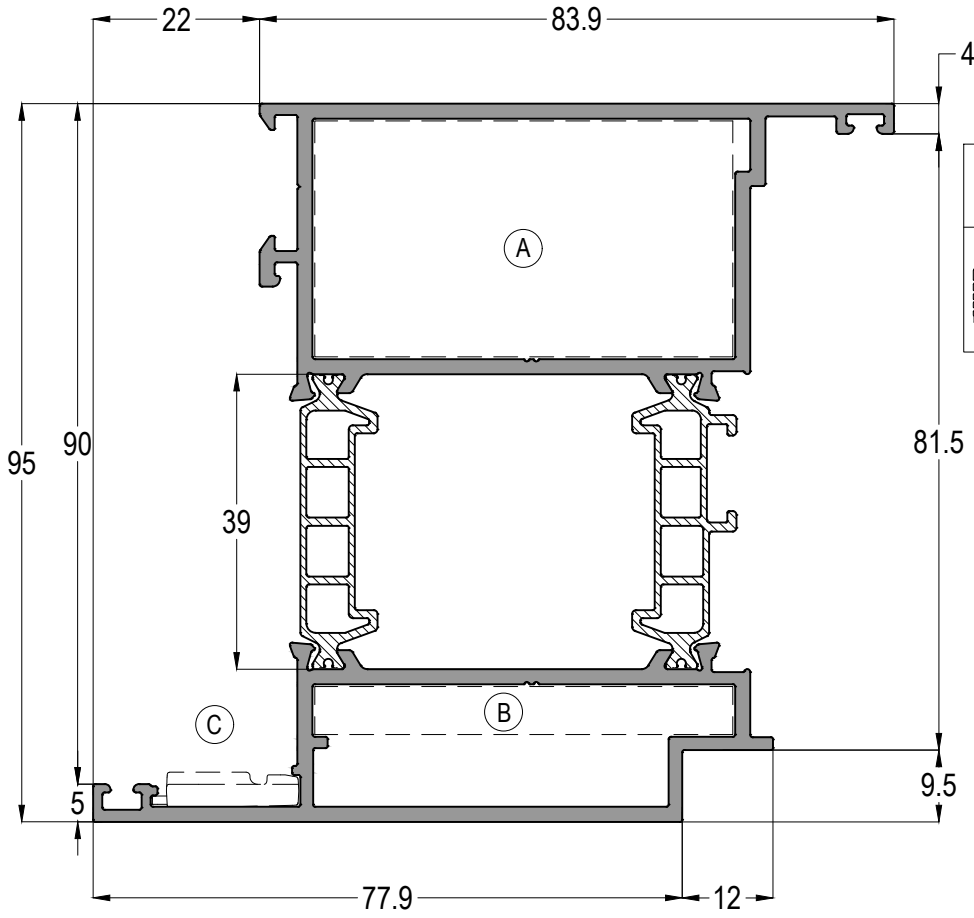

## WTD95 10

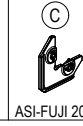

AĞIRLIK / Weight

2,614 kg/mt

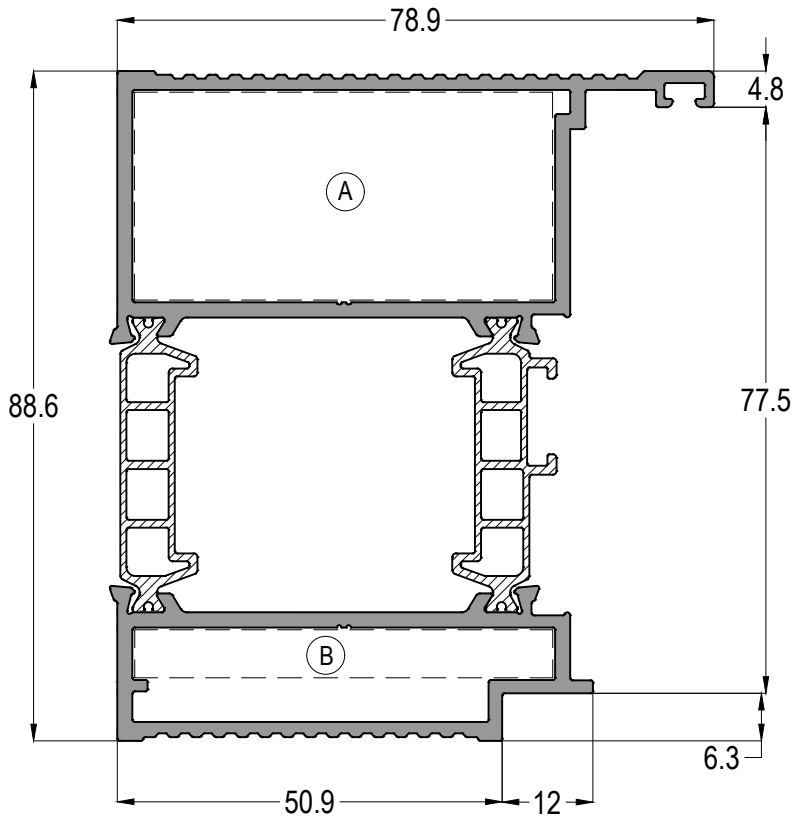

## WTD95 11



AĞIRLIK / Weight

2,267 kg/mt



# WTD95 - 2 mm

HEMYÜZ KAPI SİSTEMİ  
FLAT DOOR SYSTEM

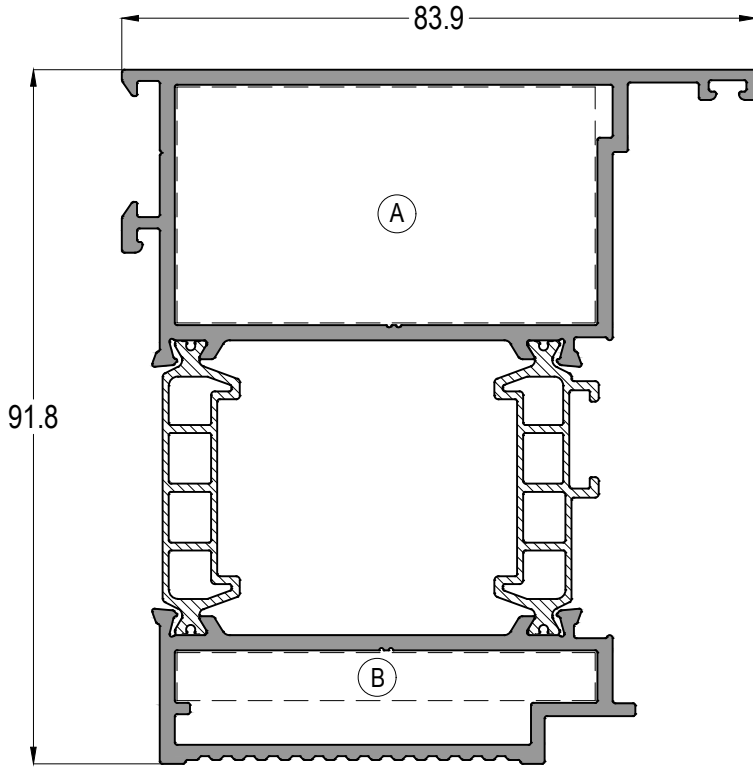
# ASISTAL



## WTD95 12

 ASI-KT 5531	 ASI-KT 5506	AĞIRLIK / Weight 2,385 kg/mt
--	--	---------------------------------

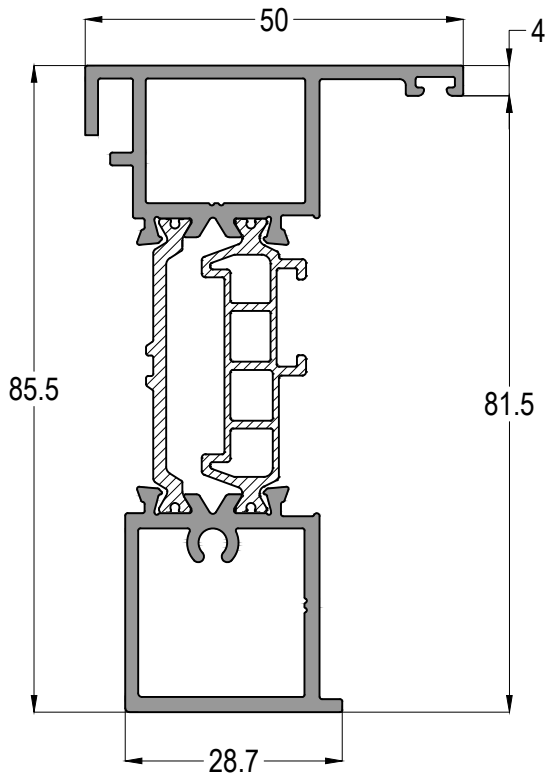

## WTD95 42

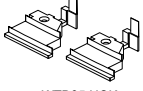
 WTD95 HOK	AĞIRLIK / Weight 1,534 kg/mt
--	---------------------------------

# WTD95 - 2 mm

HEMÜZ KAPI SİSTEMİ  
FLAT DOOR SYSTEM

## ASISTAL

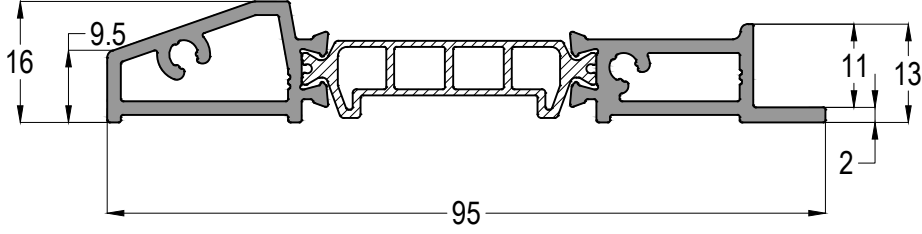

### WTD95 02

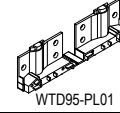

WTD95-PL01

AĞIRLIK / Weight

0,972 kg/mt

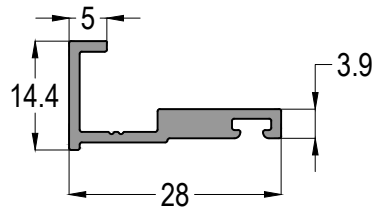

### WTD95 A01

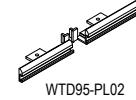

WTD95-PL02

AĞIRLIK / Weight

0,250 kg/mt

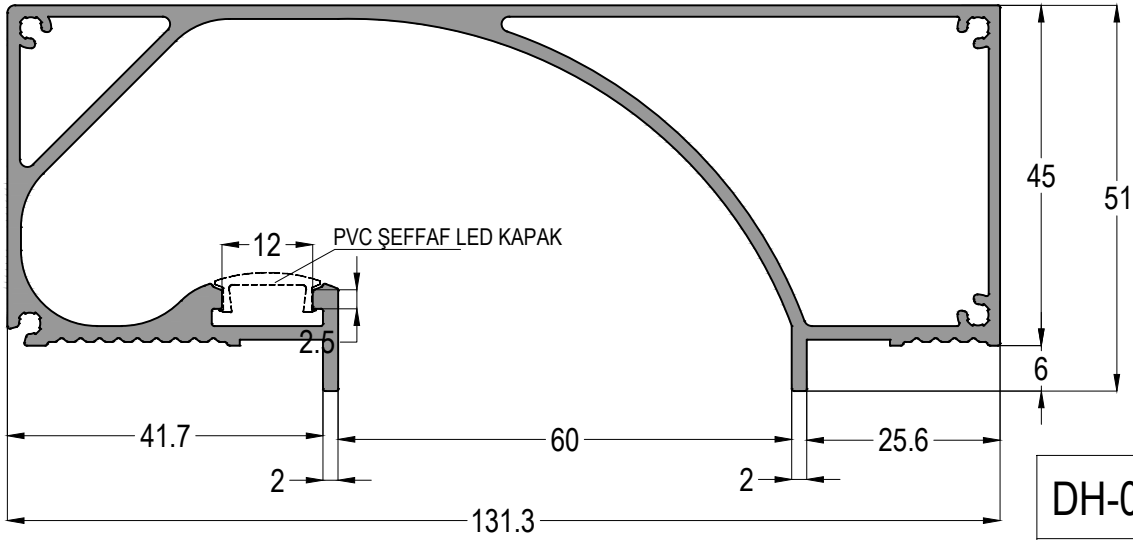

### DH-01

AĞIRLIK / Weight

2,075 kg/mt



11-106

0,202 kg/mt

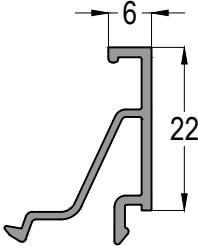

11-010

0,233 kg/mt

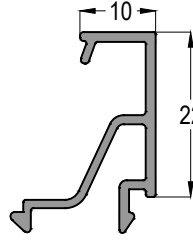

FDT80 11 NOLU KANAT İÇİN CAM ÇITASI SEÇİMİ  
GLAZING BEAD FOR FDT80 11

11-015

0,241 kg/mt

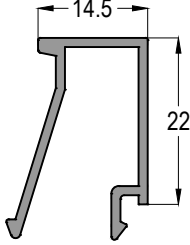

11-017

0,250 kg/mt

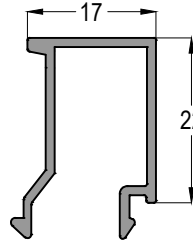

11-020

0,276 kg/mt

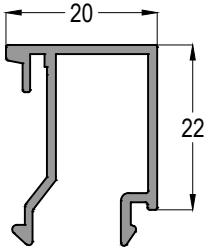

11-022

0,282 kg/mt

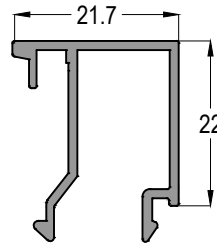

11-026

0,296 kg/mt

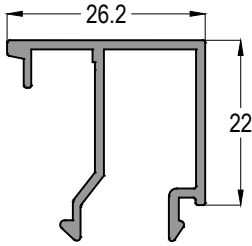

11-028

0,302 kg/mt

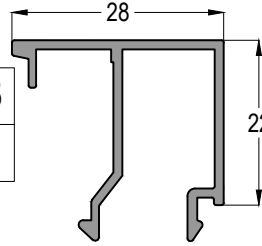

11-030

0,308 kg/mt

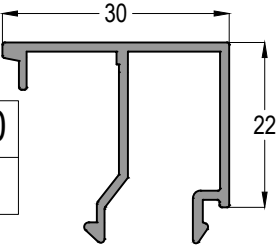

11-032

0,315 kg/mt

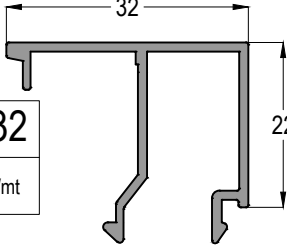

11-035

0,323 kg/mt

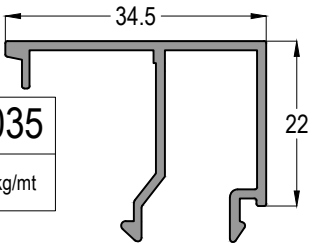

11-038

0,334 kg/mt

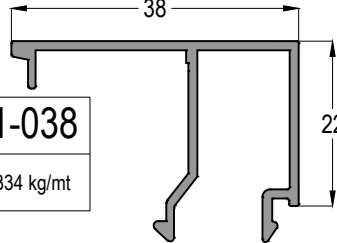

11-044

0,338 kg/mt

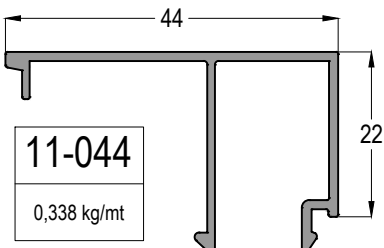

CAM KALINLIĞINA GÖRE CAM ÇITASI SEÇİM TABLOSU  
Glazing Bead Selection Table according to the Glass Thickness

CAM KALINLIĞI Glass Thickness (mm)	CAM ÇITASI Glazing Bead	İÇ CAM FİTİLİ Glass Gasket (IN)	DIŞ CAM FİTİLİ Glass Gasket (OUT)
24	11-044	EP2-01	EP1-01
28	11-038	EP2-03	EP1-01
29	11-038	EP2-02	EP1-01
30	11-038	EP2-01	EP1-01
32	11-035	EP2-03	EP1-01
33	11-035	EP2-02	EP1-01
34	11-035	EP2-01	EP1-01
35	11-032	EP2-02	EP1-01
36	11-032	EP2-02	EP1-01
37	11-030	EP2-02	EP1-01
38	11-030	EP2-01	EP1-01
39	11-028	EP2-02	EP1-01
40	11-028	EP2-01	EP1-01
41	11-026	EP2-02	EP1-01
42	11-026	EP2-01	EP1-01
44	11-022	EP2-03	EP1-01
45	11-022	EP2-02	EP1-01
46	11-022	EP2-01	EP1-01
47	11-020	EP2-02	EP1-01
48	11-020	EP2-01	EP1-01
49	11-017	EP2-02	EP1-01
50	11-017	EP2-01	EP1-01
52	11-015	EP2-03	EP1-01
53	11-015	EP2-02	EP1-01
54	11-015	EP2-01	EP1-01
56	11-010	EP2-03	EP1-01
57	11-010	EP2-02	EP1-01
58	11-010	EP2-01	EP1-01
60	11-106	EP2-03	EP1-01
61	11-106	EP2-02	EP1-01
62	11-106	EP2-01	EP1-01

**WTD95- 2 mm**

HEMYÜZ KAPI SİSTEMİ  
FLAT DOOR SYSTEM

**ASISTAL**

**SİSTEM DETAYLARI**  
*SYSTEM DETAILS*

# WTD95 - 2 mm

HEMYÜZ KAPI SİSTEMİ  
FLAT DOOR SYSTEM



## İÇE AÇILIR KAPI DETAYLARI INNER OPENING DOOR DETAILS

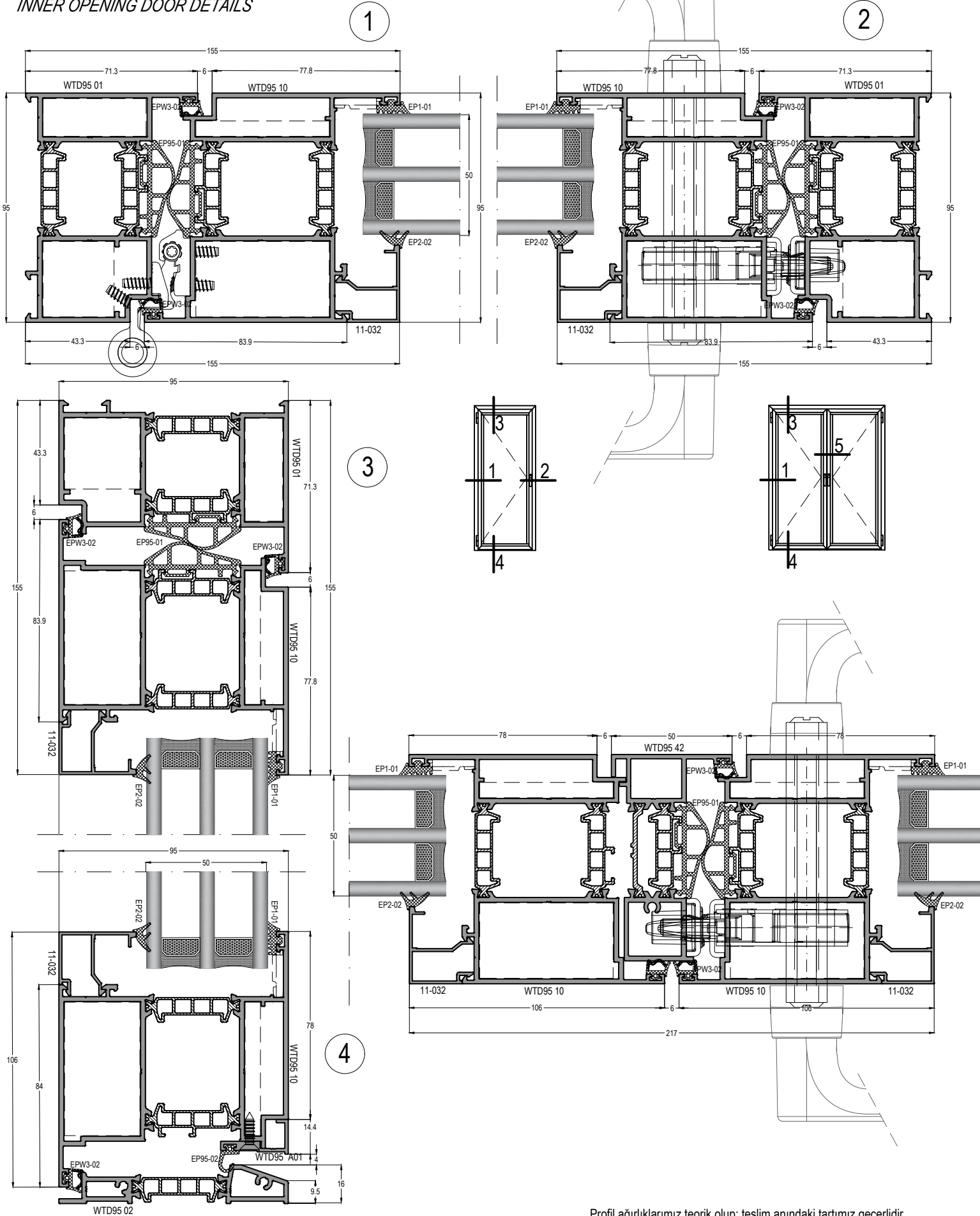

Profil ağırlıklarımız teorik olup; teslim anındaki tartımız geçerlidir.  
Profile weights are theoretical and the weight at the time of delivery is valid.

# WTD95 - 2 mm

HEMYÜZ KAPI SİSTEMİ  
FLAT DOOR SYSTEM

## ASISTAL

### İÇE AÇILIR KAPI DETAYLARI INNER OPENING DOOR DETAILS

6

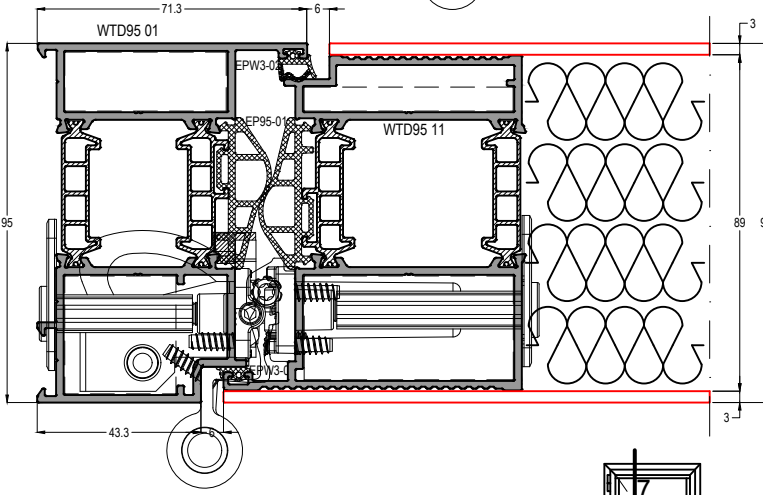

9

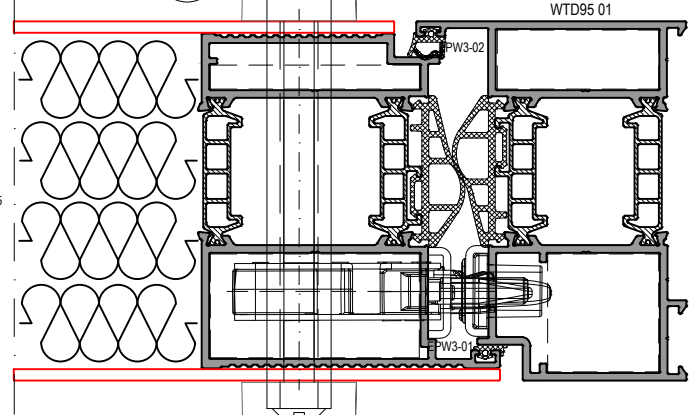

7

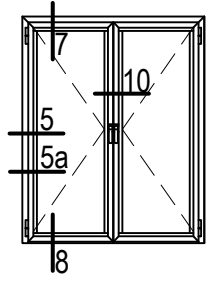
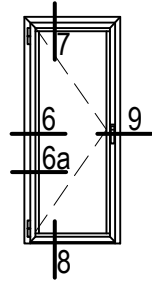
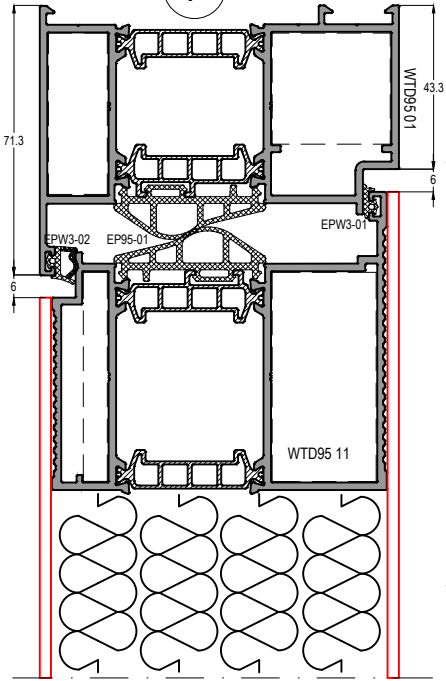

5a

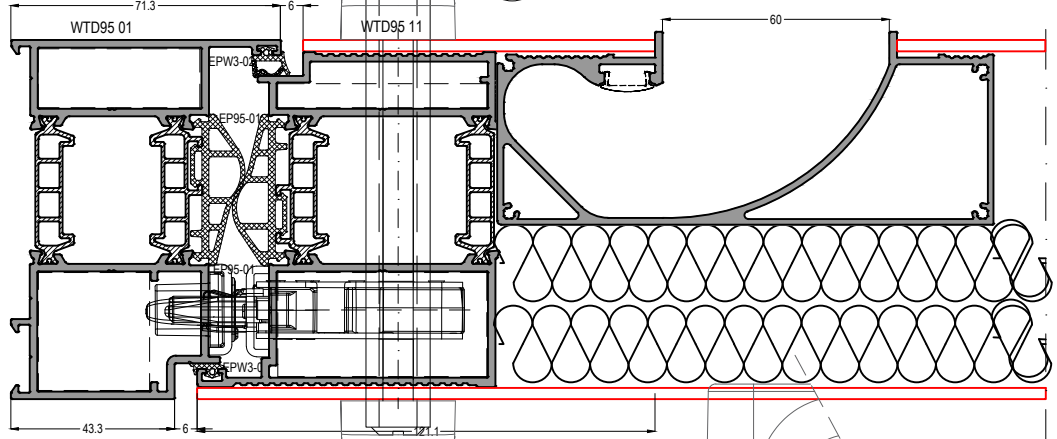

8

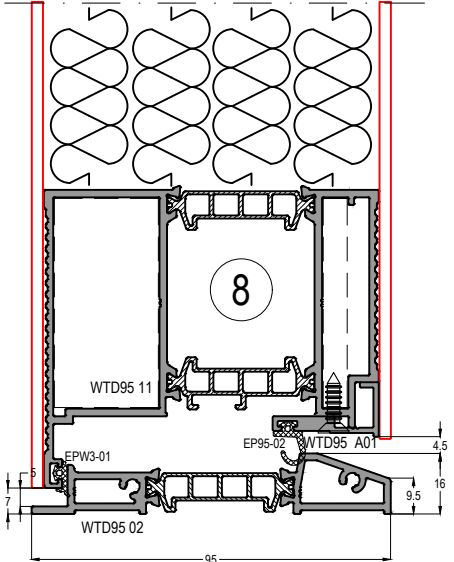

10

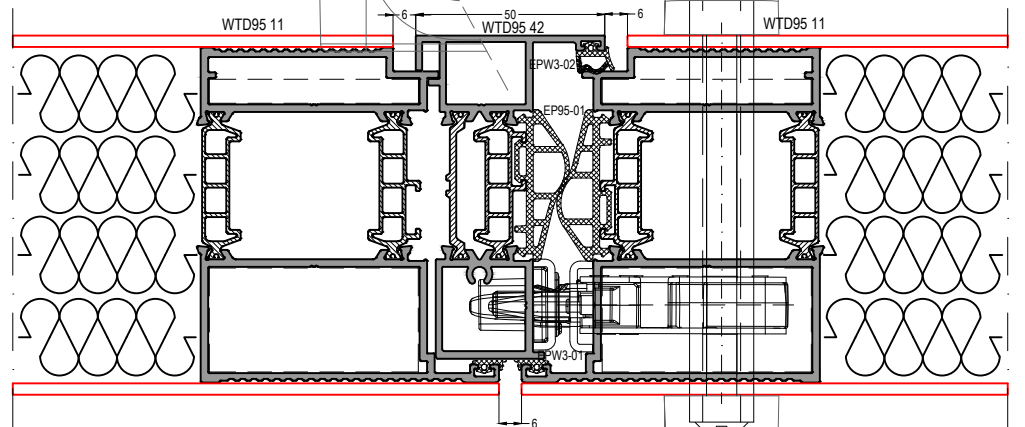

Profil ağırlıklarımız teorik olup; teslim anındaki tartımız geçerlidir.  
Profile weights are theoretical and the weight at the time of delivery is valid.

# WTD95 - 2 mm

HEMYÜZ KAPI SİSTEMİ  
FLAT DOOR SYSTEM

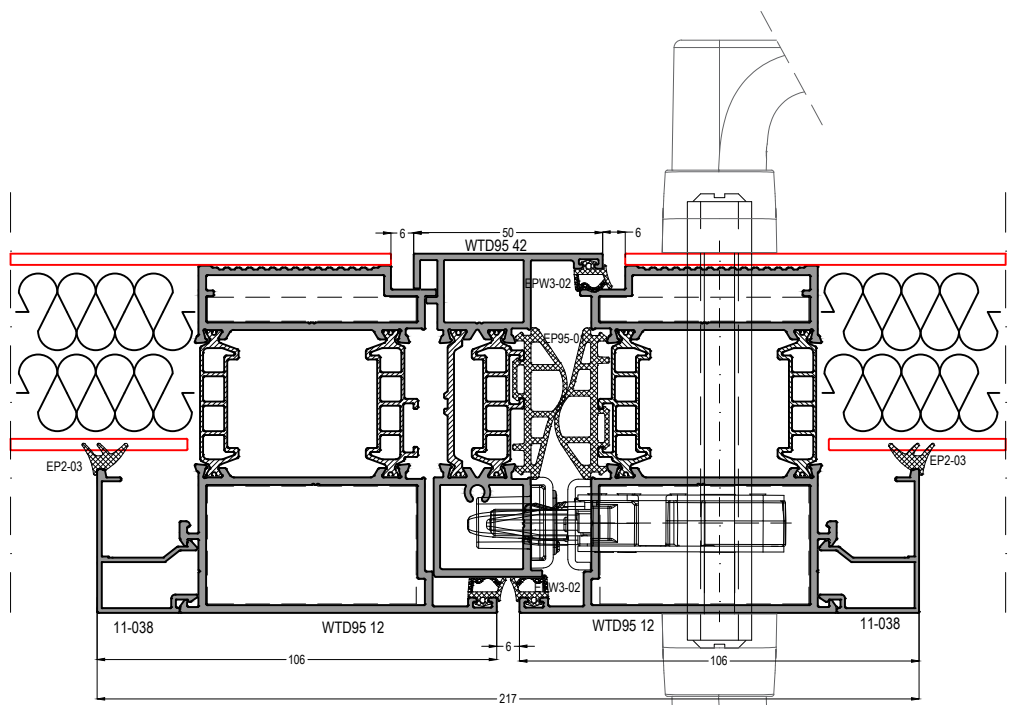
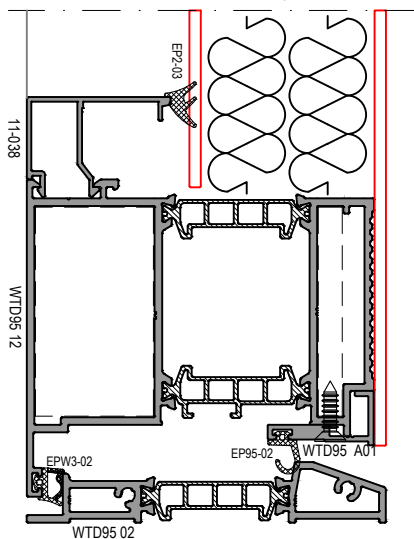
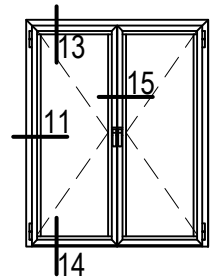
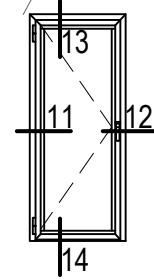
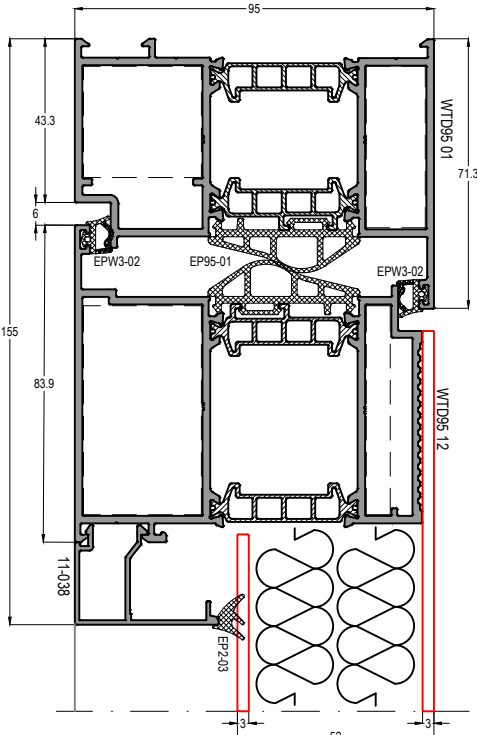
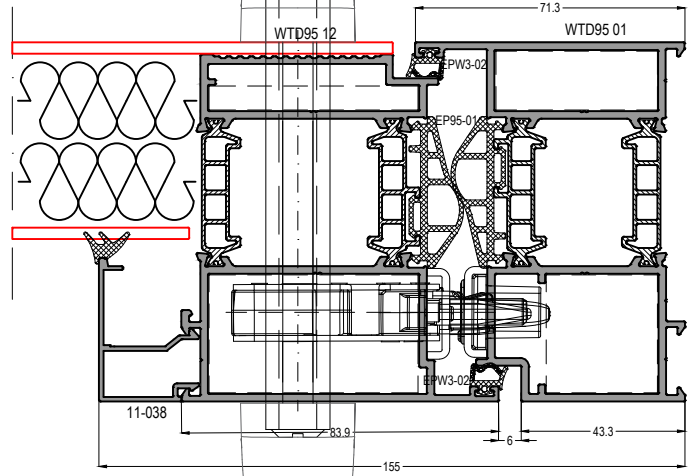
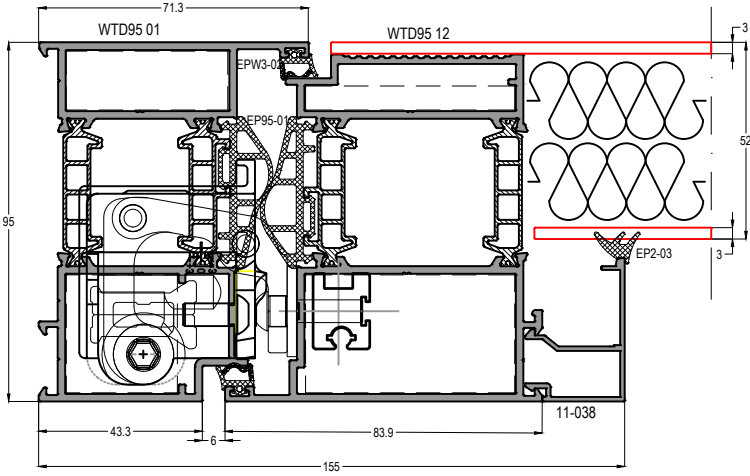

Profil ağırlıklarımız teorik olup, teslim anındaki tartımız geçerlidir.  
Profile weights are theoretical and the weight at the time of delivery is valid.