

FC50 CEPHE SİSTEMİ EK PROFİLLERİ

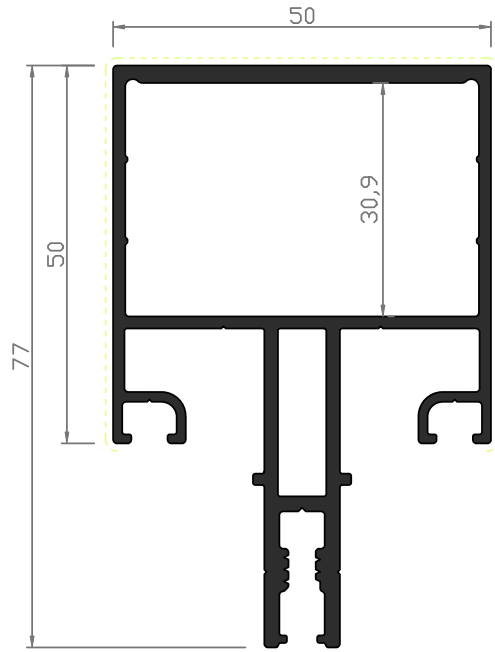

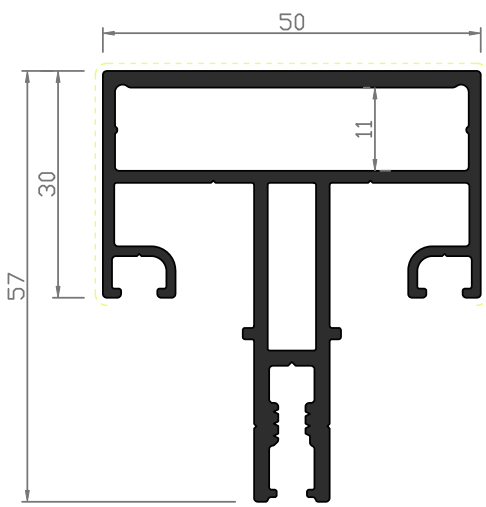

KOD
FC50-011-16 1.337 (Kg/M)

Mullion 30luk

Jxx (cm ⁴)	Jyy (cm ⁴)
13.15	10.01

KOD
FC50-012-16 1.523 (Kg/M)

Mullion 50lik

Jxx (cm ⁴)	Jyy (cm ⁴)
29.42	13.94



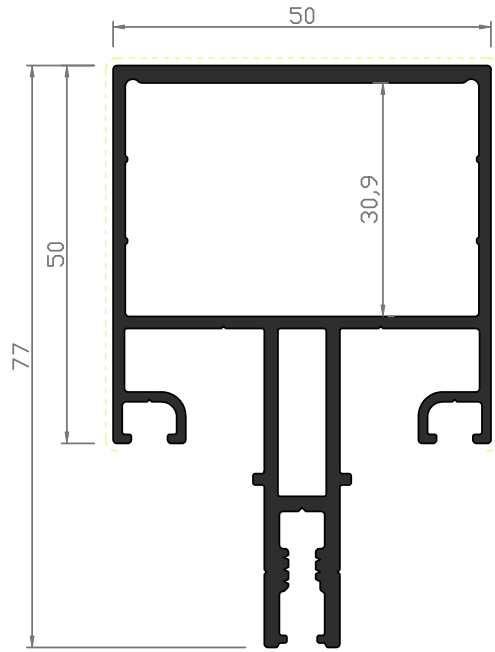
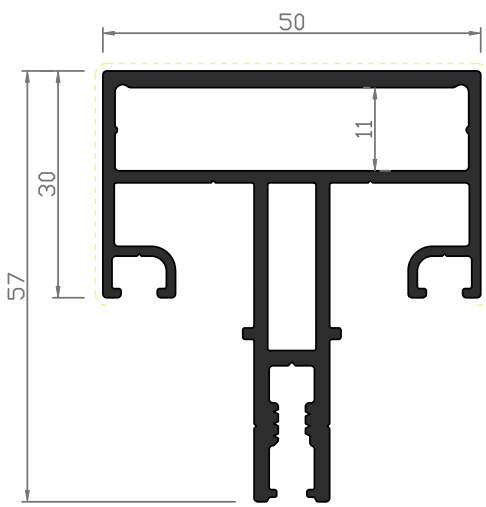

KOD
FC50-011-16 1.337 (Kg/M)

Mullion 30luk

Jxx (cm ⁴)	Jyy (cm ⁴)
13.15	10.01

KOD
FC50-012-16 1.523 (Kg/M)

Mullion 50lik

Jxx (cm ⁴)	Jyy (cm ⁴)
29.42	13.94



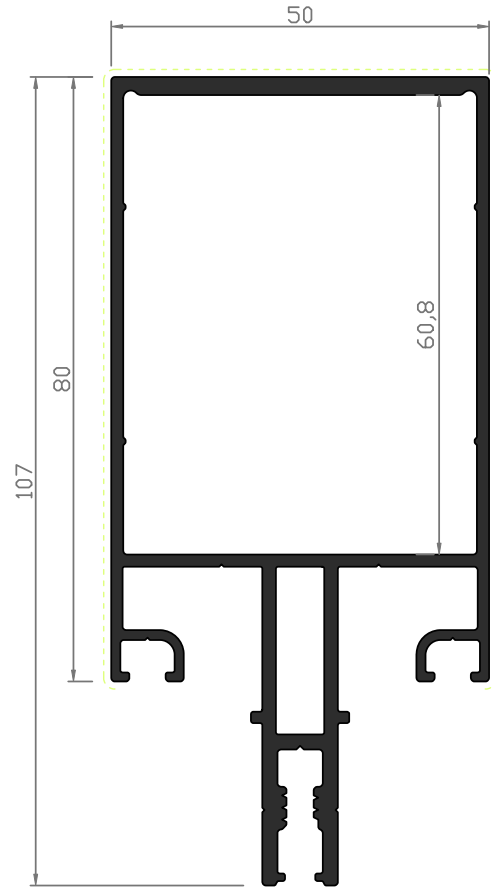
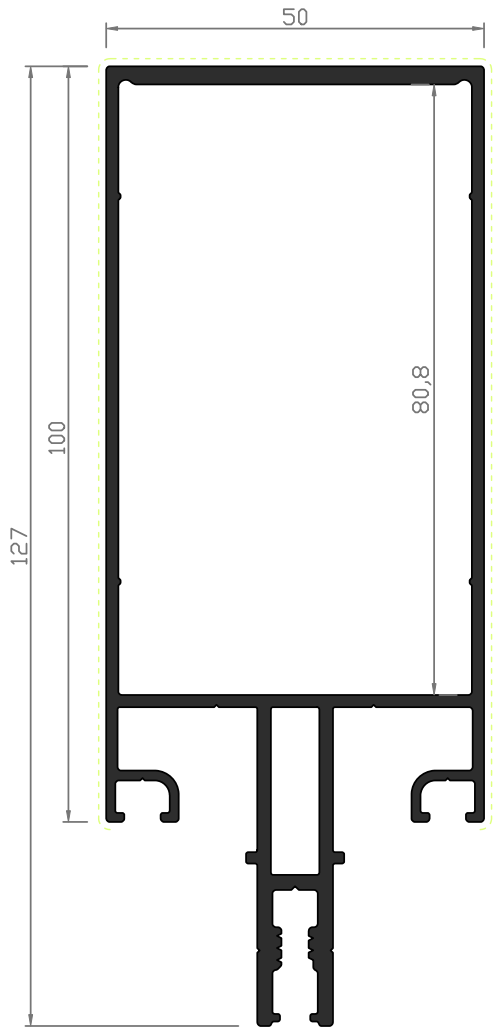

KOD
FC50-014-16

TEORİK AĞIRLIK
1.968 (Kg/M)

Mullion 100luk

Jxx (cm ⁴)	Jyy (cm ⁴)
120.82	23.38

KOD
FC50-013-16

TEORİK AĞIRLIK
1.795 (Kg/M)

Mullion 80lik

Jxx (cm ⁴)	Jyy (cm ⁴)
74.95	19.63



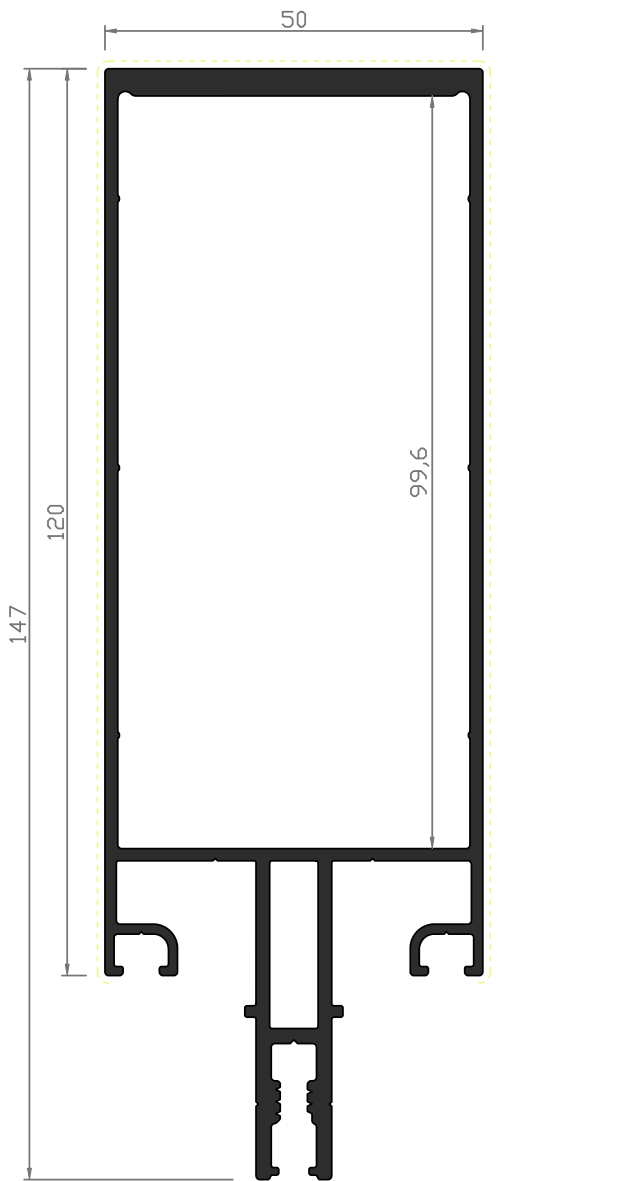

KOD
FC50-015-17
Mullion 120lik

TEORİK AĞIRLIK
2.348 (Kg/M)

Jxx (cm ⁴)	Jyy (cm ⁴)
209.67	29.23

14,79

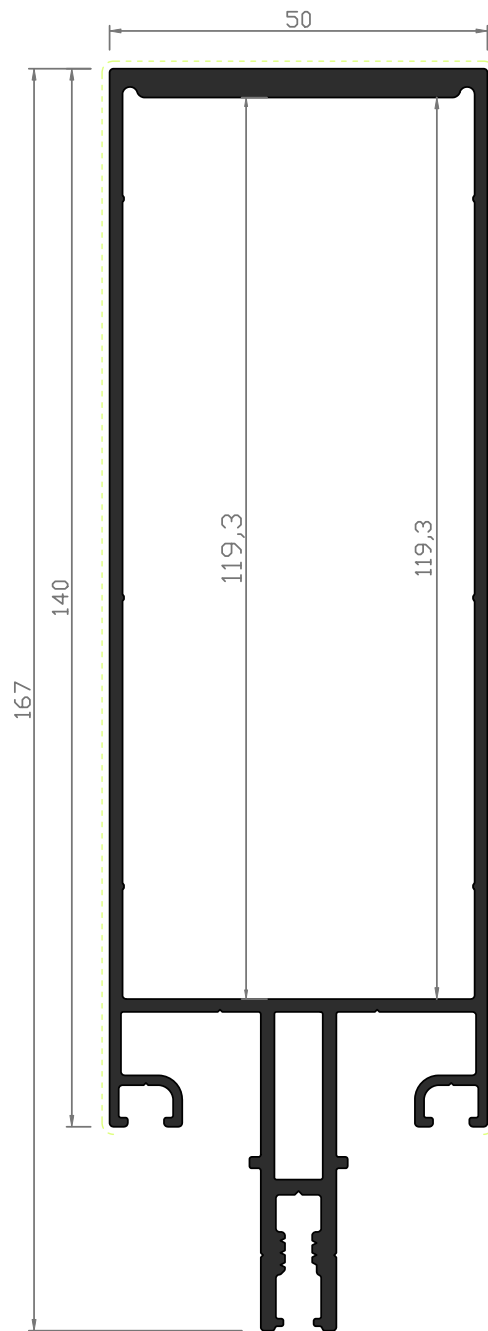

KOD
FC50-016-17
Mullion 140lik

TEORİK AĞIRLIK
2.560 (Kg/M)

Jxx (cm ⁴)	Jyy (cm ⁴)
300.08	33.28



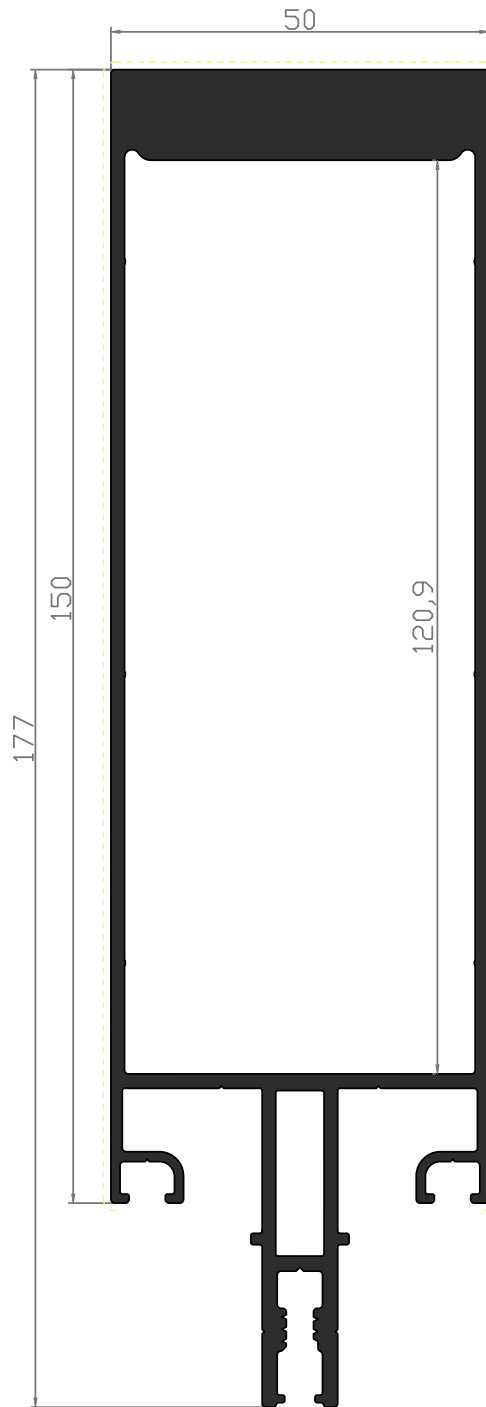

KOD
FC50-017-18

TEORİK AĞIRLIK
3.782 (Kg/M)

Mullion 150lik

Jxx (cm ⁴)	Jyy (cm ⁴)
522.65	43.62



FC50-018-20

Dikey Profil (150mm) 3135gr/m

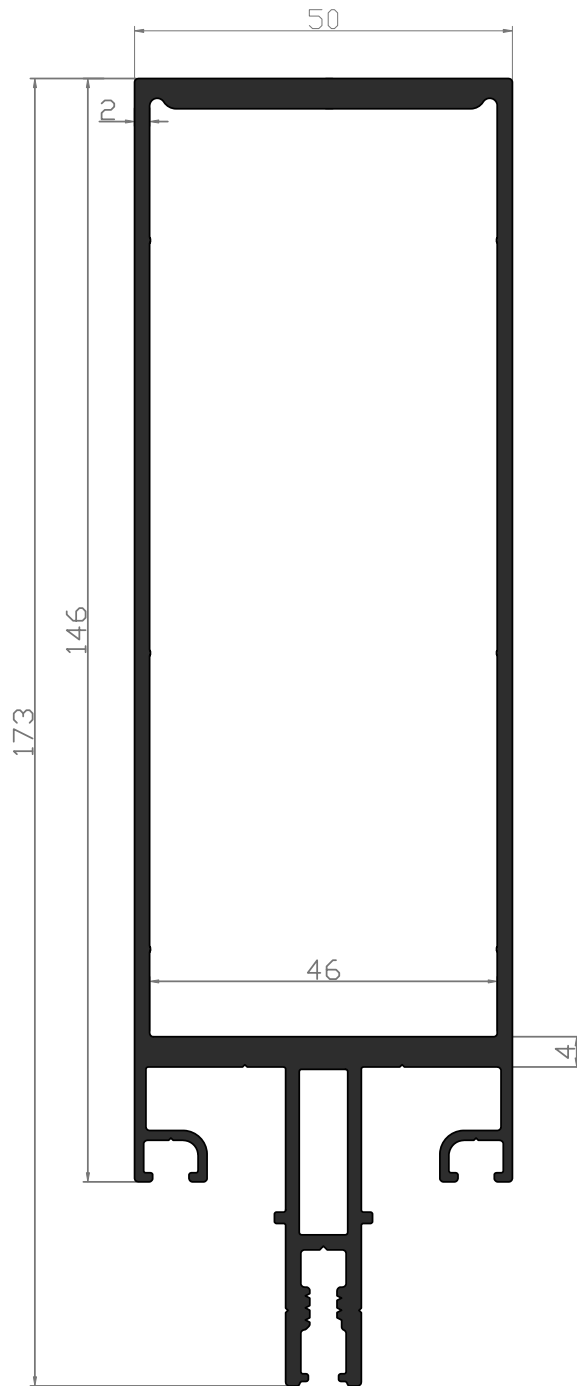

Jxx (cm ⁴)	Jyy (cm ⁴)
368,44	40,50



FC50-019-20

Dikey Profil (170mm) 3351gr/m

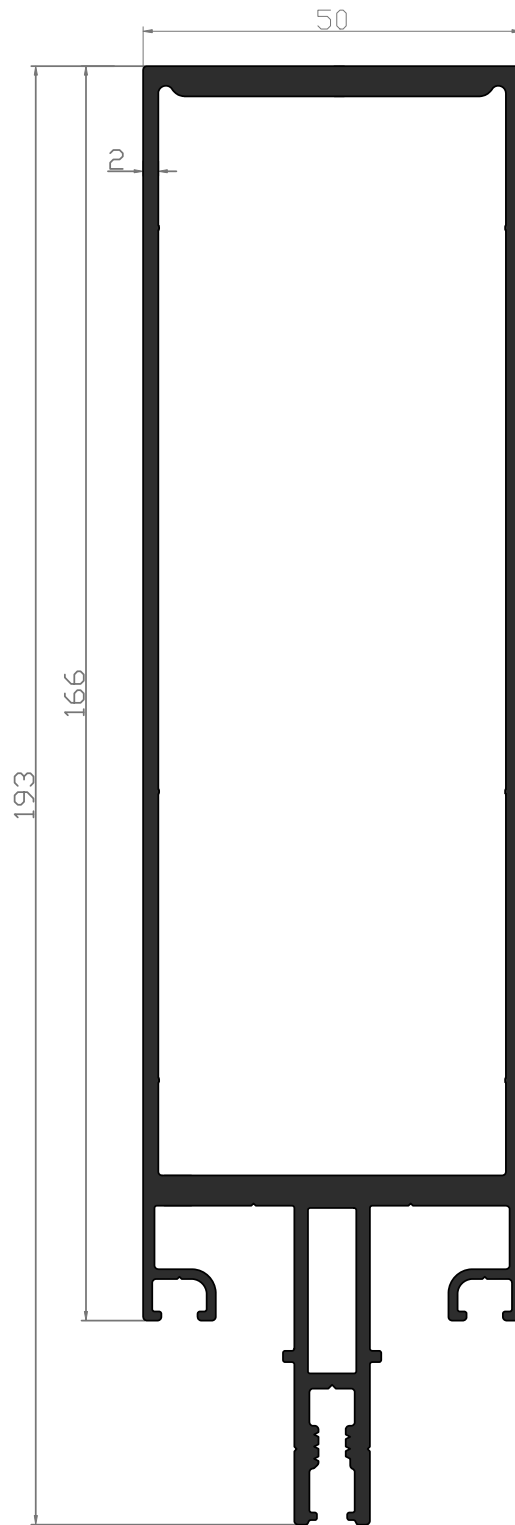

Jxx (cm ⁴)	Jyy (cm ⁴)
497,91	45,11



FC50-020-20
 Dikey Profil (190mm) 3878gr/m

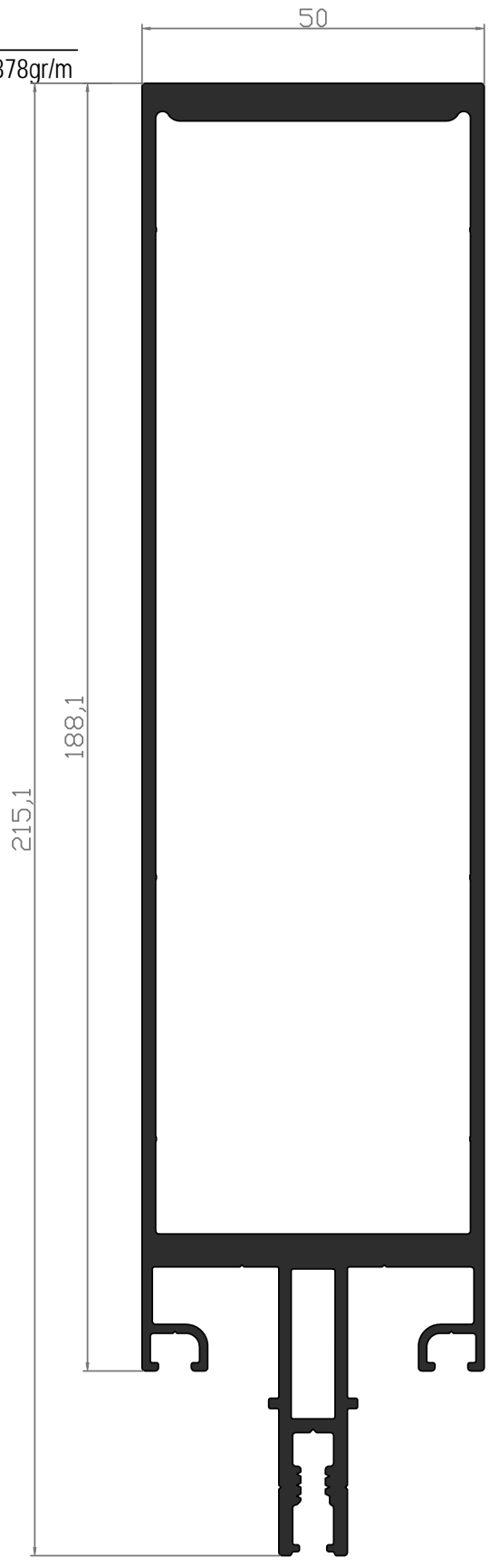

Jxx (cm ⁴)	Jyy (cm ⁴)
755,29	52,07



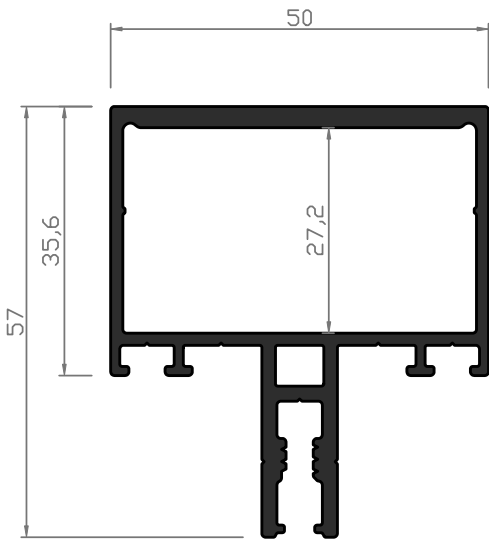

KOD
FC50-211-16

Mullion K.G.30lik

TEORİK AĞIRLIK
1.233 (Kg/M)

Jxx (cm ⁴)	Jyy (cm ⁴)
14.39	10.83

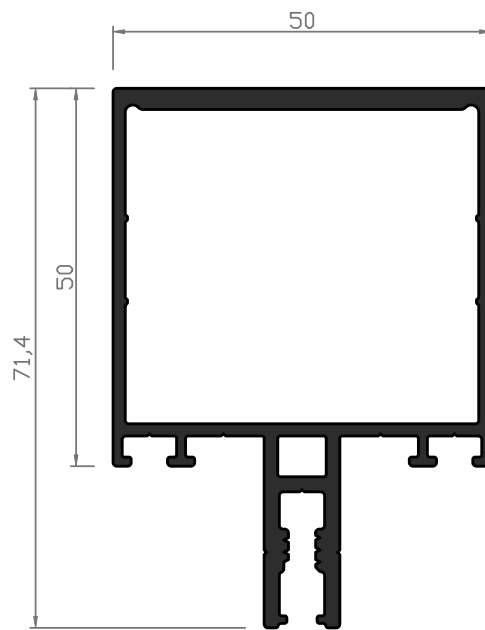

KOD
FC50-212-16

Mullion K.G.50lik

TEORİK AĞIRLIK
1.359 (Kg/M)

Jxx (cm ⁴)	Jyy (cm ⁴)
27.26	13.56



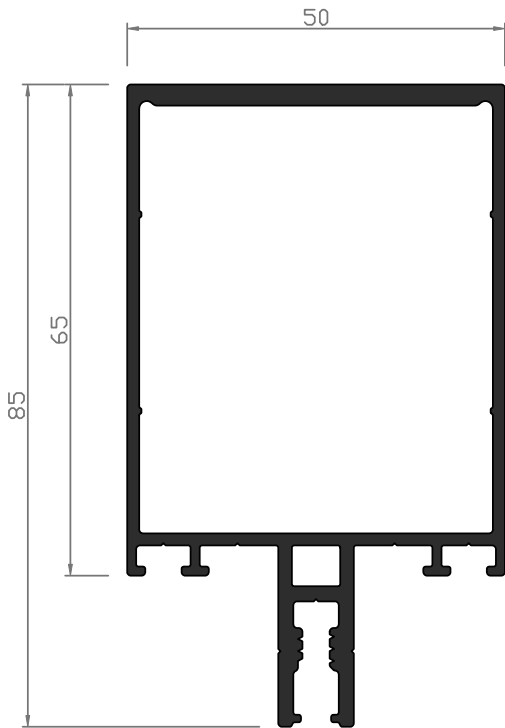

KOD
FC50-313-16

TEORİK AĞIRLIK
1.474 (Kg/M)

Jxx (cm ⁴)	Jyy (cm ⁴)
44.78	16.36

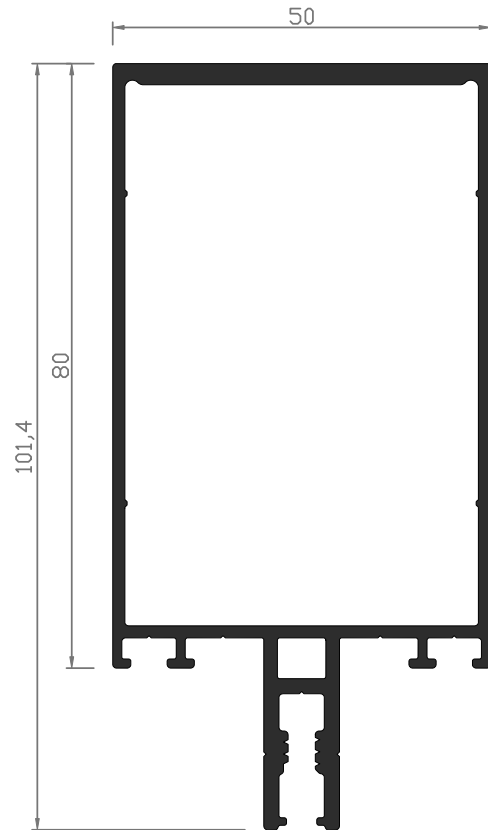

KOD
FC50-213-16

TEORİK AĞIRLIK
1.619 (Kg/M)

Mullion K.G.80lik

Jxx (cm ⁴)	Jyy (cm ⁴)
71.20	19.18



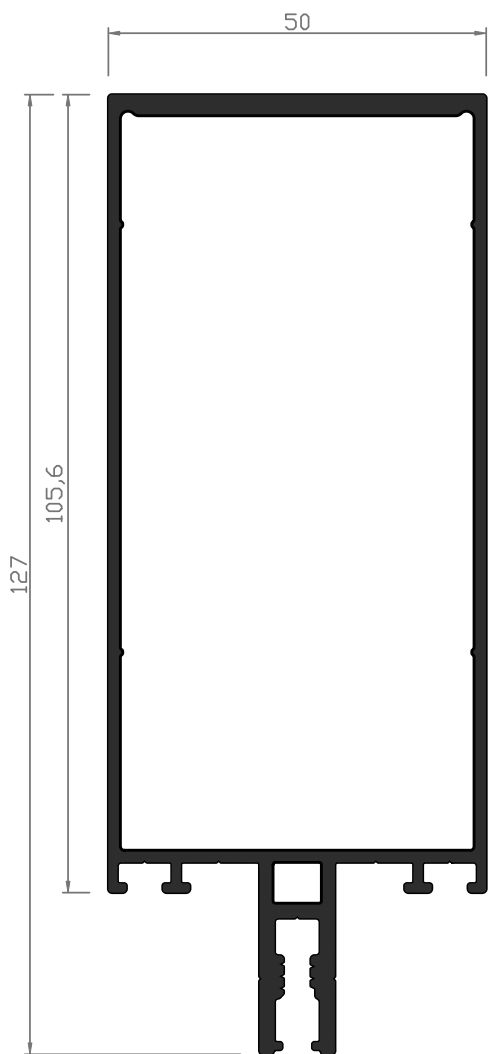

KOD
FC50-214-16

Mullion K.G.100lik

TEORİK AĞIRLIK
1.841 (Kg/M)

Jxx (cm ⁴)	Jyy (cm ⁴)
129.68	23.98

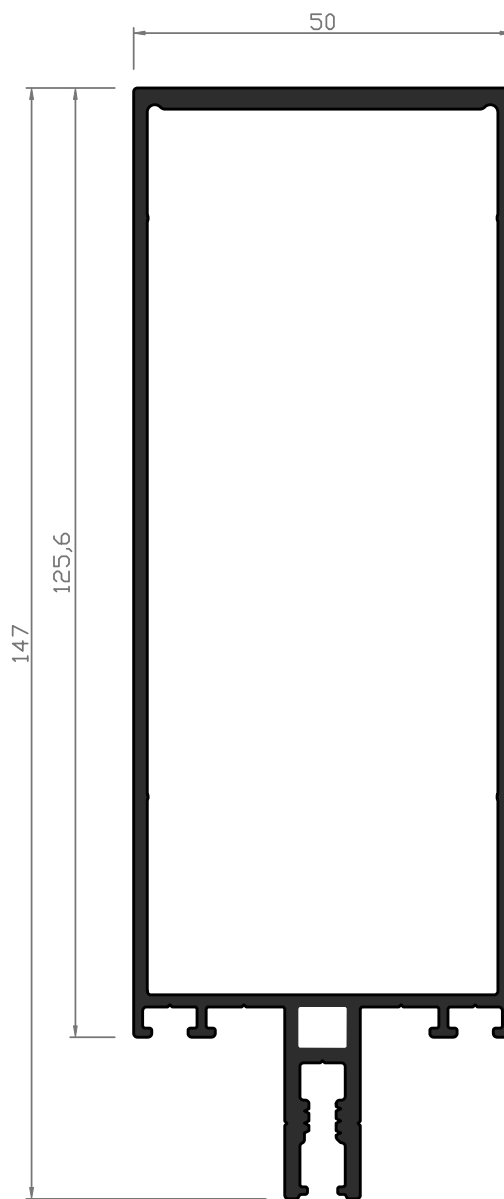

KOD
FC50-215-16

Mullion K.G.125lik

TEORİK AĞIRLIK
2.139 (Kg/M)

Jxx (cm ⁴)	Jyy (cm ⁴)
196.35	30.24



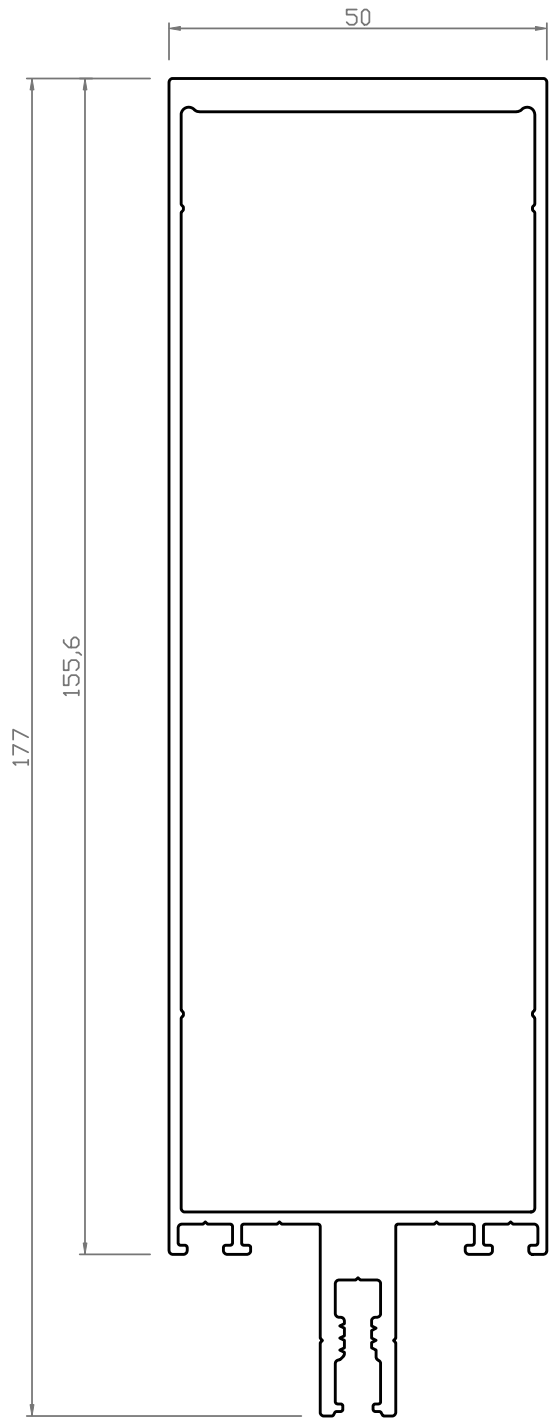

KOD
FC50-217-17
 Mullion 150lik

TEORİK AĞIRLIK
2.477 (Kg/M)

Jxx (cm ⁴)	Jyy (cm ⁴)
357.65	34.72



SY80-016-20
SKY PROFİLLERİ 3228 gr/m

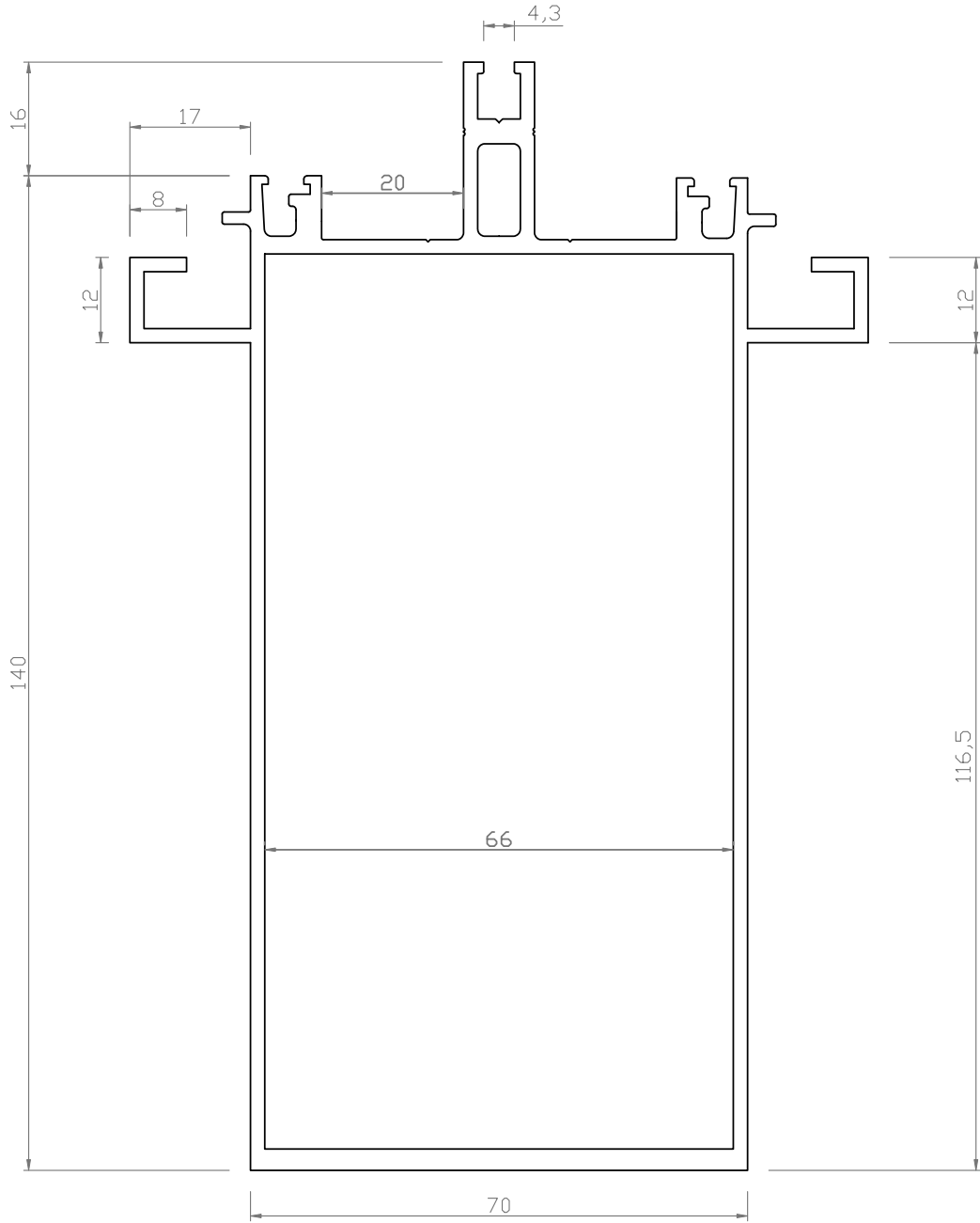

Dilatasyon Profili

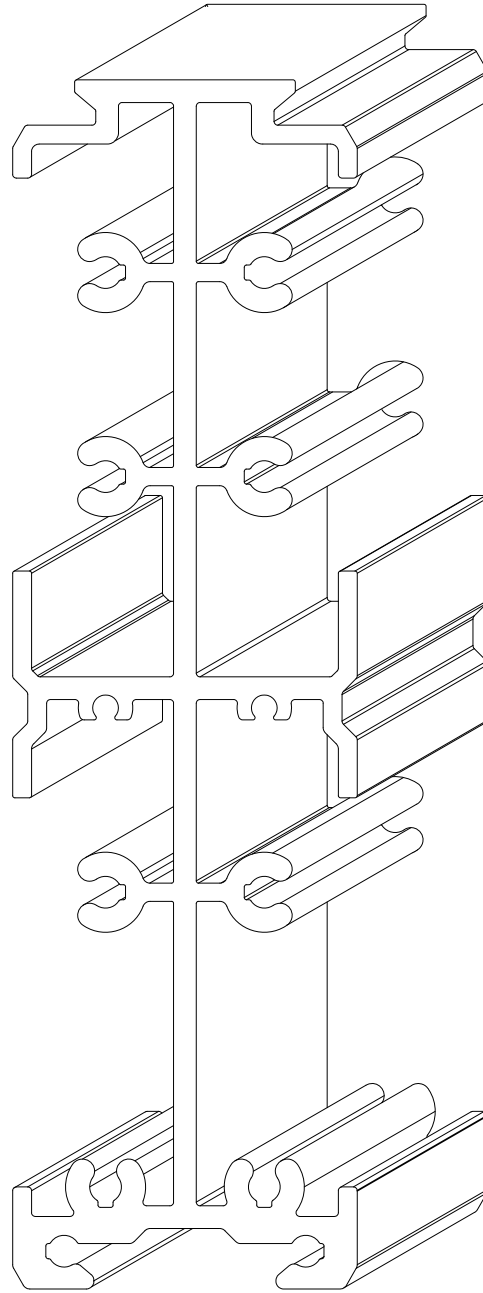

FC10-160-03

Profil Kod	Kesim Ölçüsü(mm)	Kesilmiş Kodu
FC50-012-16	30.5 mm	AW4530
FC50-013-16	60.5 mm	AW4560
FC50-014-16	80.5 mm	AW4580



FC50-015-17

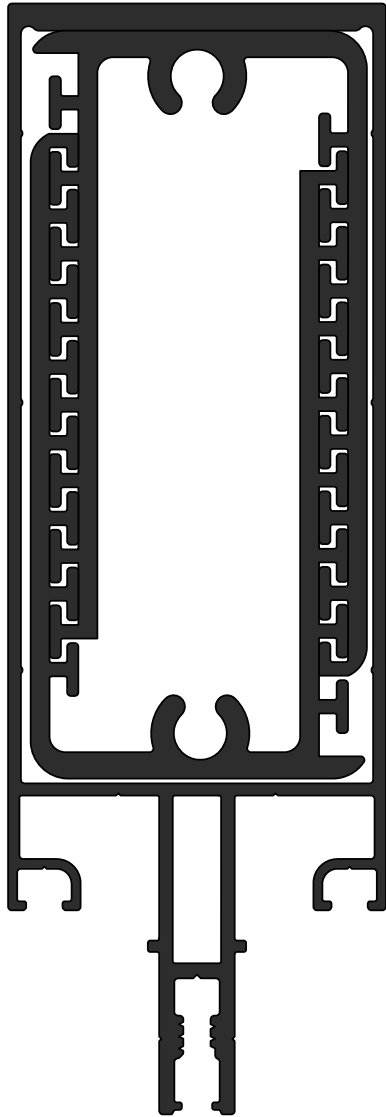

FC50-016-17

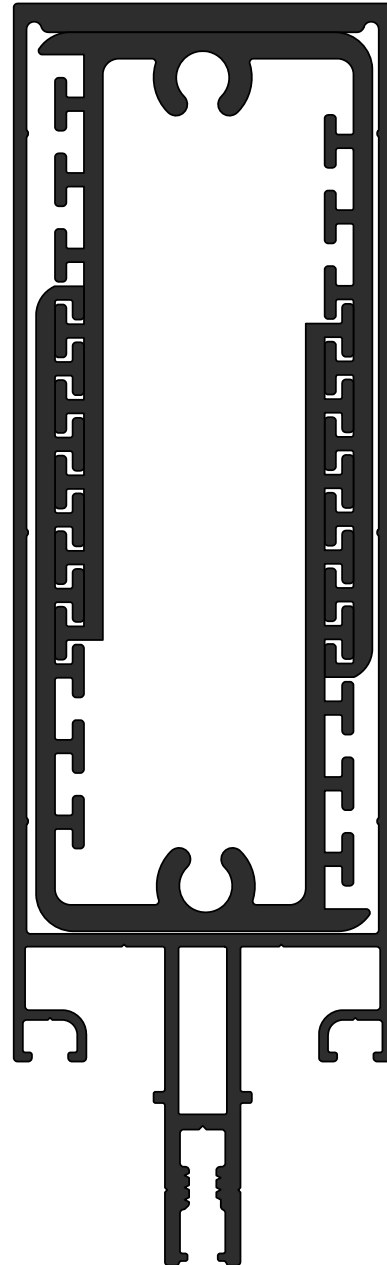

FC50-017-18

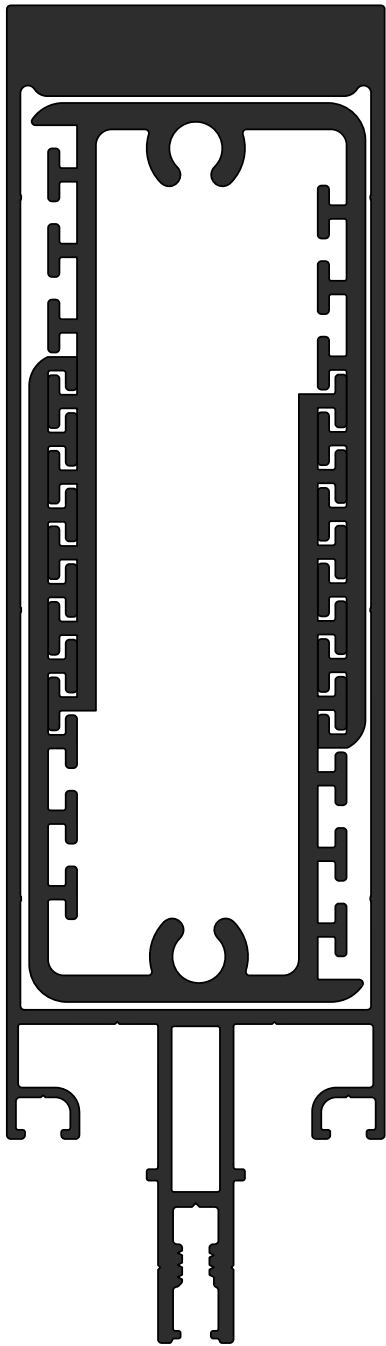

FC50-018-20

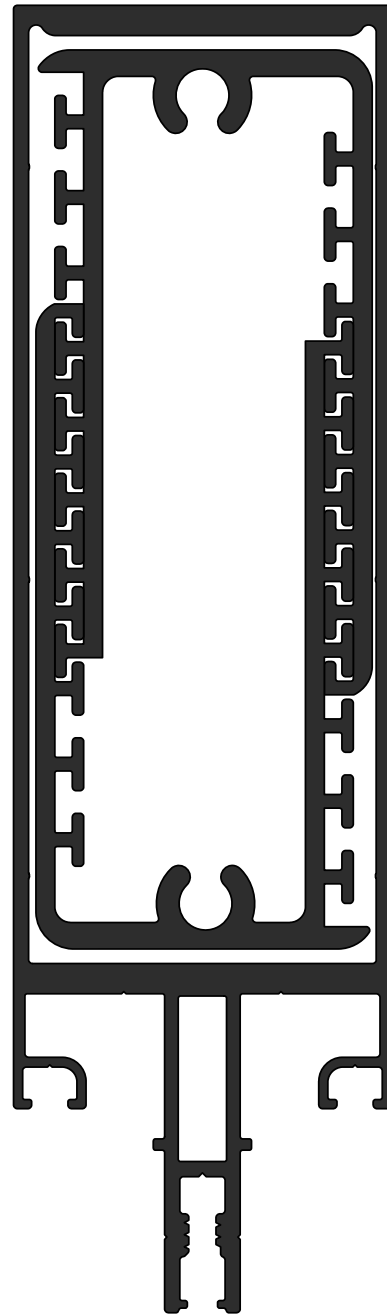

FC50-019-20

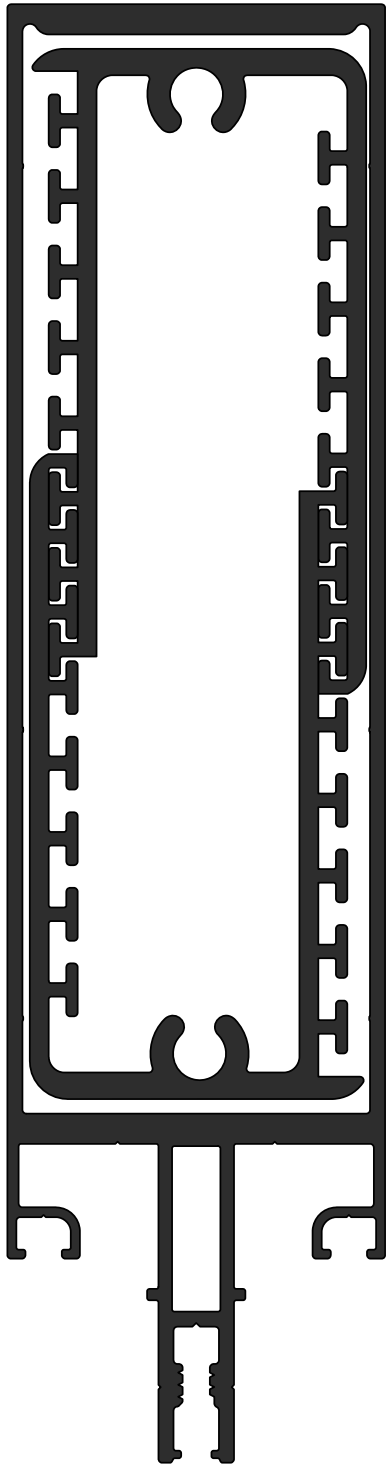

FC50-020-20

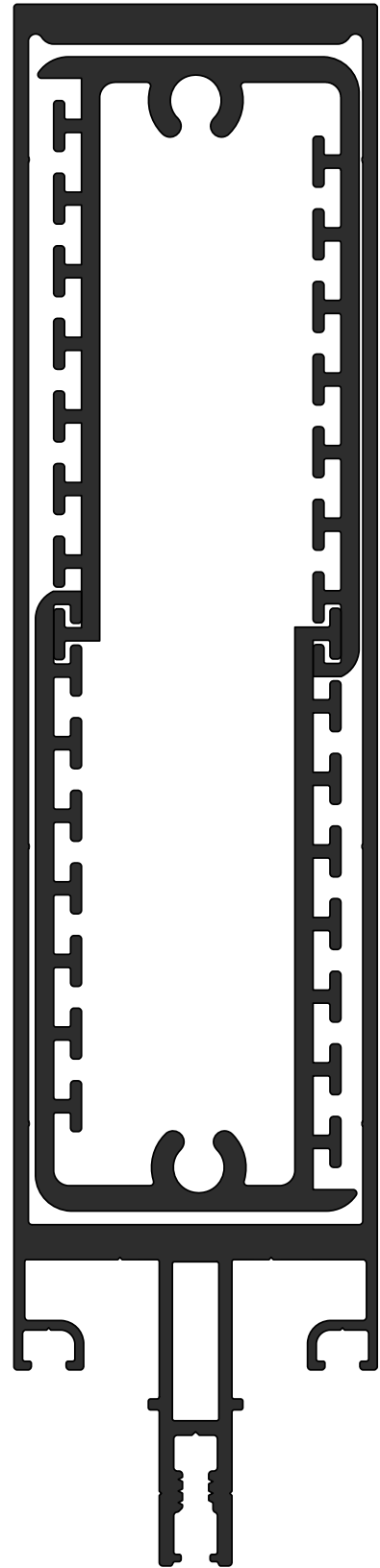

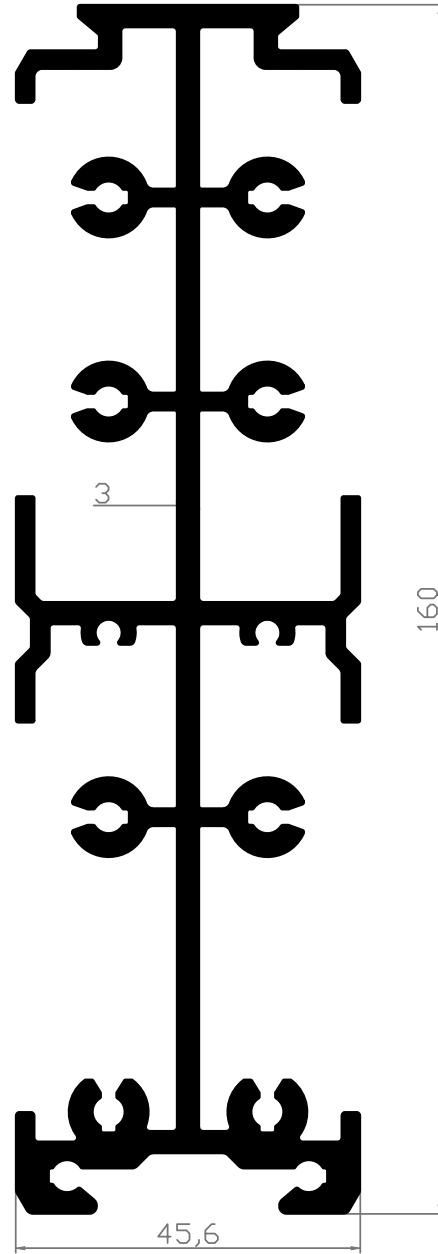

KOD FC10-160-03 TEORİK AĞIRLIK 4.484 (Kg/M)
Dilatasyon Profili



FC10-161-25

Dilatasyon Profili 2198gr/m

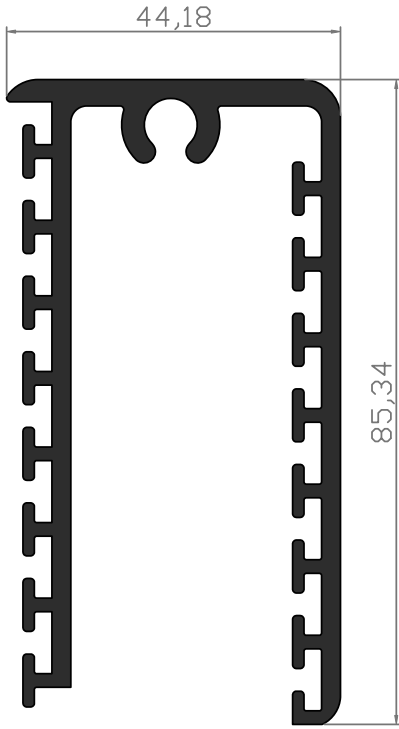

FC10-467-35

Yatay profil bağlantı profili 992gr/m

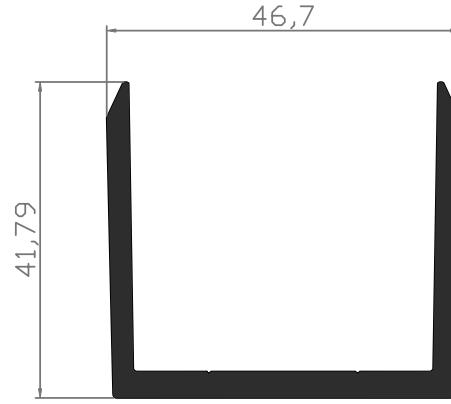

FC12-239-13

Silikon Cephe kaset profili 447gr/m

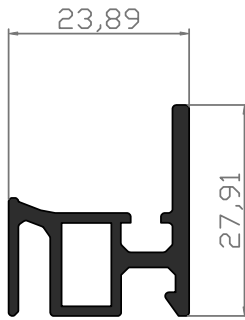

FC12-438-14

Silikon cephe cam takozu 516gr/m

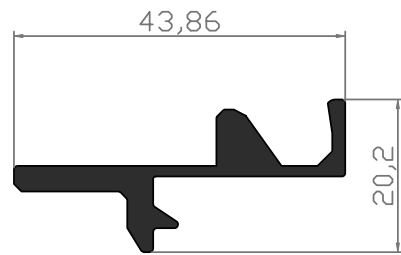

FC12-240-15

Silikon cephe emniyet bağlantısı 431 gr/m

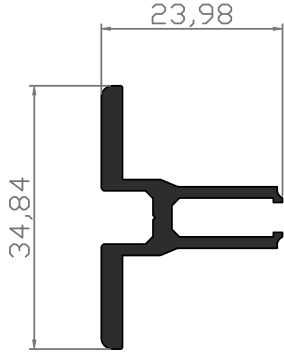

FC12-344-25

Kapaklı Cephe Cam takozu 270gr/m

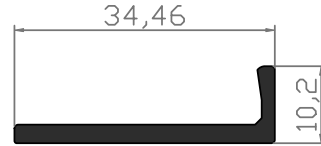

FC12-320-20

Silikon Cephe çift kulak sabitleme klipsi 263gr/m

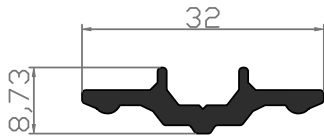

FC12-220-20

Silikon cephe tek kulak cam sabitleme klipsi 193gr/m

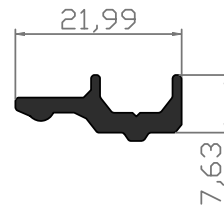

FC50-039-20

Düsey kapak 90° 870 gr/m

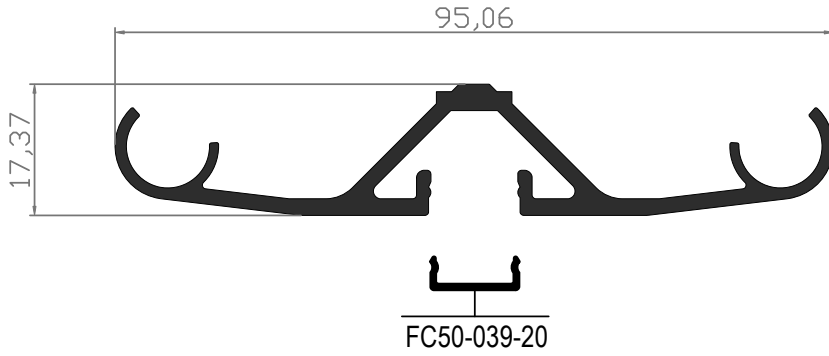

FC50-134-15

Alt baskı kapağı 90° 905 gr/m

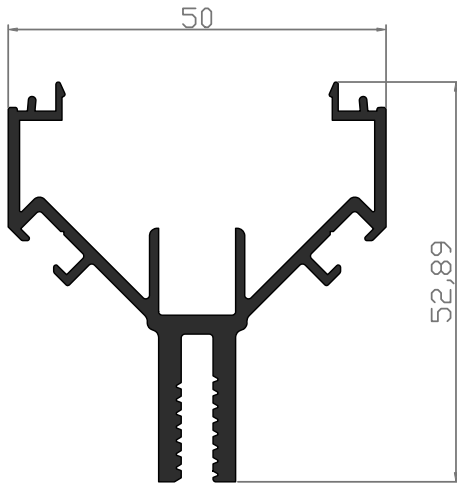

FC12-110-12

Düsey kapak 90° Fitol profili 133gr/m

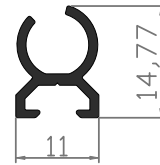

FC12-200-20

Yatay Kapak 532gr/m

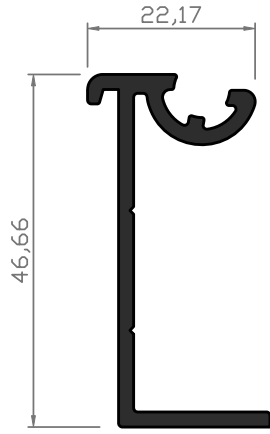

FC12-210-20

Yatay Baskı kapağı 624 gr/m

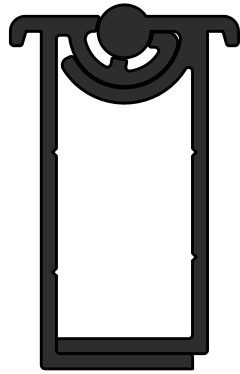
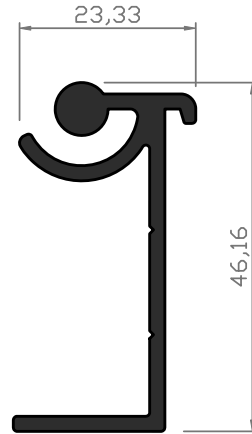

FC12-181-12

Gizli kanat kasası 149 gr/m

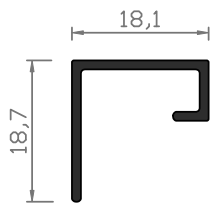

FC12-490-16

Gizli kanat kasası 392 gr/m

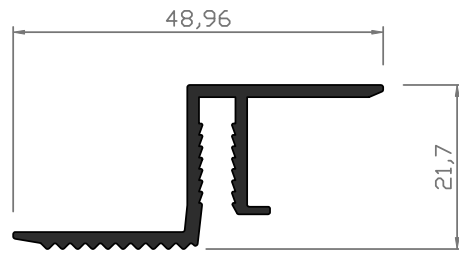

FC12-365-13

Yatay Kapak 286gr/m

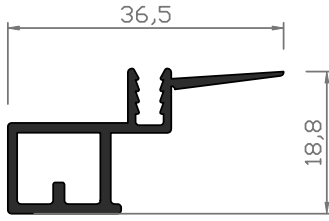

FC12-401-13

Yatay Baskı kapağı 467 gr/m

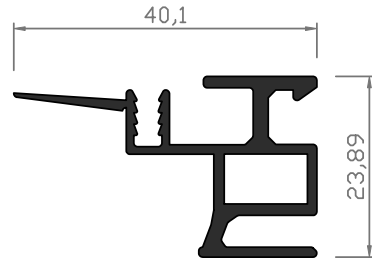

FC12-203-15

Gizli kanat kasası 162 gr/m

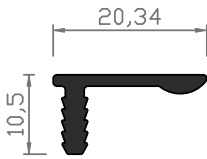

FC50-038-14
Yatay Kapak 278 gr/m

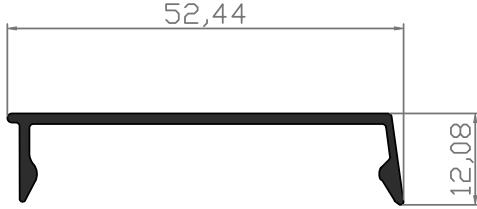

FC50-135-15
Yatay Baskı kapağı 322 gr/m

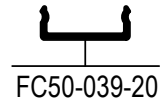
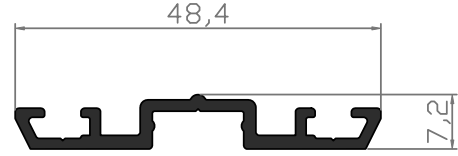

FC50-123-14
Gizli kanat kasası 681 gr/m

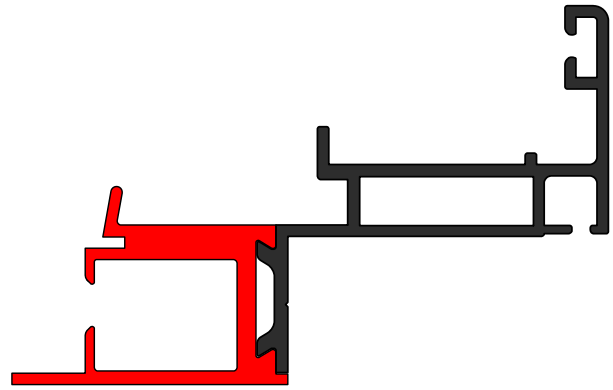
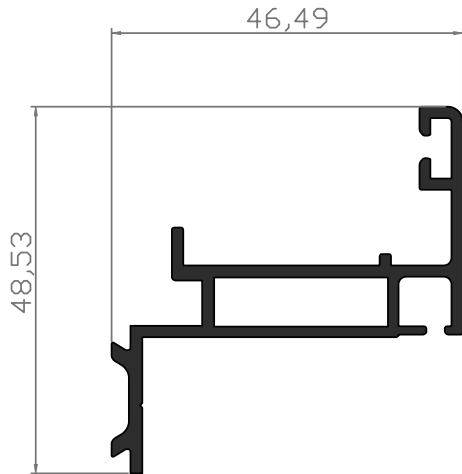

PF50-10

Gizli kanat kasa karşılık plastiği

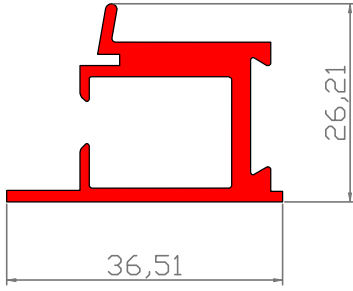

PF50-11

Karşılık yatay kapağı

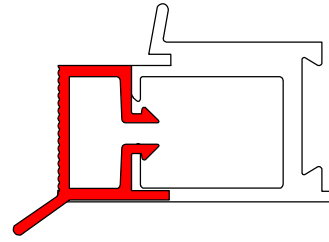
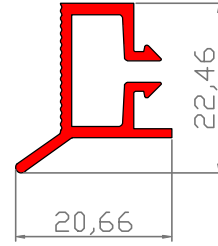

PF50-12

Karşılık Yatay kapağı

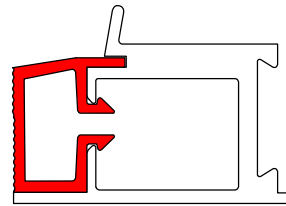
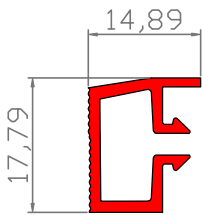

PF50-03

Kapaklı cephe gaga uzatmaları

PF50-02

Kapaklı cephe gaga uzatmaları

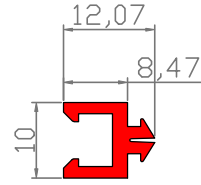
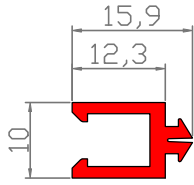

CE9-01

Kaset fitili

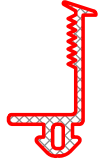

CE8-01

Yatay cephe fitili



CE8-02

Dikey cephe fitili

